

USER MANUAL

NORTH AMERICA

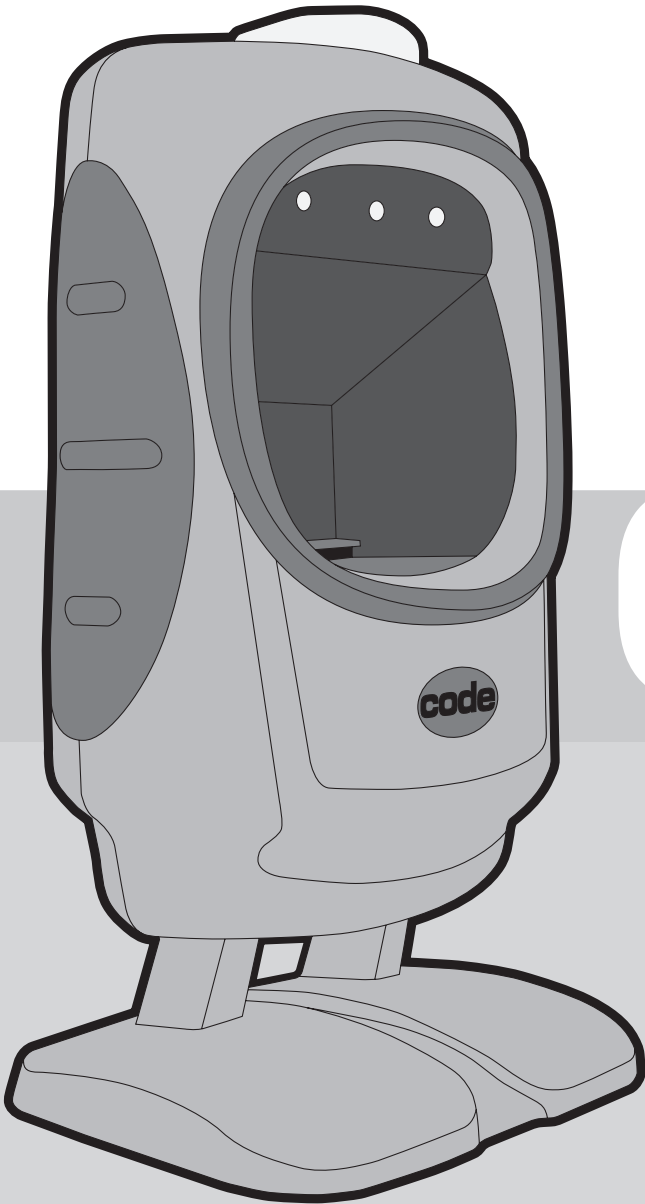

CR5200

MANUAL VERSION 01
RELEASE DATE: MARCH 2021



www.codecorp.com



Configuration Guide



[YouTube.com/codecorporation](https://www.youtube.com/codecorporation)

code[®]

Statement of Agency Compliance

NOTE: This equipment has been tested and found to comply with the limits for a Class B digital device, pursuant to part 15 of the FCC Rules. These limits are designed to provide reasonable protection against harmful interference in a residential installation. This equipment generates, uses and can radiate radio frequency energy and, if not installed and used in accordance with the instructions, may cause harmful interference to radio communications. However, there is no guarantee that interference will not occur in a particular installation. If this equipment does cause harmful interference to radio or television reception, which can be determined by turning the equipment off and on, the user is encouraged to try to correct the interference by one or more of the following measures:

- Reorient or relocate the receiving antenna.
- Increase the separation between the equipment and receiver.
- Connect the equipment into an outlet on a circuit different from that to which the receiver is connected.
- Consult the dealer or an experienced radio/TV technician for help.

Industry Canada (IC)

This device complies with Industry Canada licence-exempt RSS standard(s). Operation is subject to the following two conditions: (1) this device may not cause interference, and (2) this device must accept any interference, including interference that may cause undesired operation of the device.

Industrie Canada (IC)

Le présent appareil est conforme aux CNR d'Industrie Canada applicables aux appareils radio exempts de licence. L'exploitation est autorisée aux deux conditions suivantes : (1) l'appareil ne doit pas produire de brouillage, et (2) l'utilisateur de l'appareil doit accepter tout brouillage radioélectrique subi, même si le brouillage est susceptible d'en compromettre le fonctionnement.

Code Reader™ 5200 User Manual

Copyright © 2020-2021 Code Corporation.

All Rights Reserved.

The software described in this manual may only be used in accordance with the terms of its license agreement.

No part of this publication may be reproduced in any form or by any means without written permission from Code Corporation. This includes electronic or mechanical means such as photocopying or recording in information storage and retrieval systems.

NO WARRANTY. This technical documentation is provided AS-IS. Further, the documentation does not represent a commitment on the part of Code Corporation. Code Corporation does not warrant that it is accurate, complete or error free. Any use of the technical documentation is at the risk of the user. Code Corporation reserves the right to make changes in specifications and other information contained in this document without prior notice, and the reader should in all cases consult Code Corporation to determine whether any such changes have been made. Code Corporation shall not be liable for technical or editorial errors or omissions contained herein; nor for incidental or consequential damages resulting from the furnishing, performance, or use of this material. Code Corporation does not assume any product liability arising out of or in connection with the application or use of any product or application described herein.

NO LICENSE. No license is granted, either by implication, estoppel, or otherwise under any intellectual property rights of Code Corporation. Any use of hardware, software and/or technology of Code Corporation is governed by its own agreement.

The following are trademarks or registered trademarks of Code Corporation:

CodeXML®, Maker, QuickMaker, CodeXML® Maker, CodeXML® Maker Pro, CodeXML® Router, CodeXML® Client SDK, CodeXML® Filter, HyperPage, CodeTrack, GoCard, GoWeb, ShortCode, GoCode®, Code Router, QuickConnect Codes, Rule Runner®, Cortex®, CortexRM, CortexMobile, Code®, Code Reader, CortexAG, CortexStudio, CortexTools®, Affinity®, and CortexDecoder®.

All other product names mentioned in this manual may be trademarks of their respective companies and are hereby acknowledged.

The software and/or products of Code Corporation include inventions that are patented or that are the subject of patents pending. A complete list of patents are available at www.codecorp.com/legal/patents.php.

The Code Reader software uses the Mozilla SpiderMonkey JavaScript engine, which is distributed under the terms of the Mozilla Public License Version 1.8.

The Code Reader software is based in part on the work of the Independent JPEG Group.

Code Corporation, 434 West Ascension Way, Ste 300, Murray UT, 84123

www.codecorp.com

Table of Contents

1.0 - ProductList.....	4
2.0 - Included Items.....	5
3.0 - Attaching and Detaching a Cable.....	6
4.0 - RS232 and USB Set Up.....	6
5.0 - Using a CR5200 in Presentation Mode.....	7
6.0 - Using a CR5200 in Handheld Mode.....	7
7.0 - Reading Ranges.....	7
8.0 - Reader Feedback.....	8
9.0 - Symbologies Defaulted On.....	8
10.0 - Symbologies Defaulted Off.....	8
11.0 - Reader ID & Firmware Version.....	9
12.0 - CR5200AV.....	9
13.0 - CR5200 Overall Dimensions.....	10
14.0 - USB Cable Example with Pinouts.....	10
15.0 - RS232 Cable Example with Pinouts.....	11
16.0 - Reader Pinouts.....	11
17.0 - CR5200 Maintenance.....	11
18.0 - Warranty.....	12

1.0 - Product List

The following tables summarize the parts included within the CR5200 series product line. More product details can be found on [Code's website](#).

Product Kits

<u>Part Number</u>	<u>Description</u>
CR5210-200-C500	Code Reader Kit - CR5200 (Cabled, Dark Gray, Presentation), 6-ft Straight USB Cable
CR5210-200-C502	Code Reader Kit - CR5200 (Cabled, Dark Gray, Presentation), 6-ft Straight RS232 Cable
CR5210-200-C502-P1	Code Reader Kit - CR5200 (Cabled, Dark Gray, Presentation), 6-ft Straight RS232 Cable, US Power Supply
CR5210-200-C503	Code Reader Kit - CR5200 (Cabled, Dark Gray, Presentation), 8-ft Coiled RS232 Cable, US Power Supply
CR5210-200-CX	Code Reader Only - CR5200 (Cabled, Dark Gray, Presentation)
CR5215-200-C500	Code Reader Kit - CR5200 with Built-In Age Verificaon (Cabled, Dark Gray, Presentation), 6-ft Straight USB Cable
CR5215-200-C502	Code Reader Kit - CR5200 with Built-In Age Verificaon (Cabled, Dark Gray, Presentation), 6-ft Straight RS232 Cable
CR5215-200-C502-P1	Code Reader Kit - CR5200 with Built-In Age Verificaon (Cabled, Dark Gray, Presentation), 6-ft Straight RS232 Cable,US Power Supply

Accessories

<u>Part Number</u>	<u>Description</u>
CR2AG-P1	Code Reader Accessory for All Readers except CR4405 - US Power Supply for RS232
CR2AG-P2	Code Reader Accessory for All Readers except CR4405 - EU Power Supply for RS232

Cables

<u>Part Number</u>	<u>Description</u>
CRA-C500	Code Reader Accessory for All Cabled Readers - 6-ft Straight USB Cable
CRA-C501	Code Reader Accessory for All Cabled Readers - 8-ft Coiled RS232 Cable
CRA-C502	Code Reader Accessory for All Cabled Readers - 6-ft Straight RS232 Cable
CRA-C503	Code Reader Accessory for All Cabled Readers - 8-ft Coiled RS232 Cable, US Power Supply

*Other CR5200 series [service](#) and [warranty](#) options can be found on Code's website.

2.0 - Included Items (if Ordered)

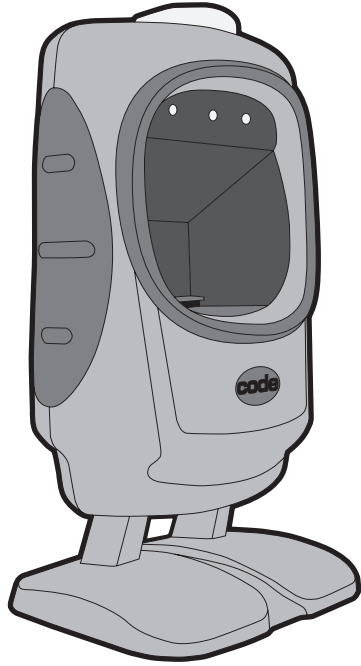

CR5200
(Model #: CR5210 or CR5215)

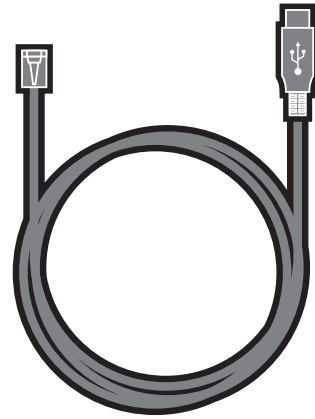

USB 2.0 Cable

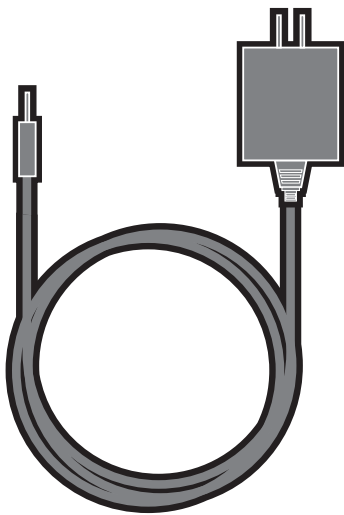

5VDC
Power Supply

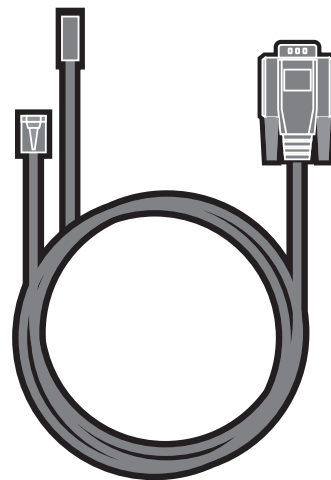

RS232 Cable

3.0 - Attaching and Detaching a Cable

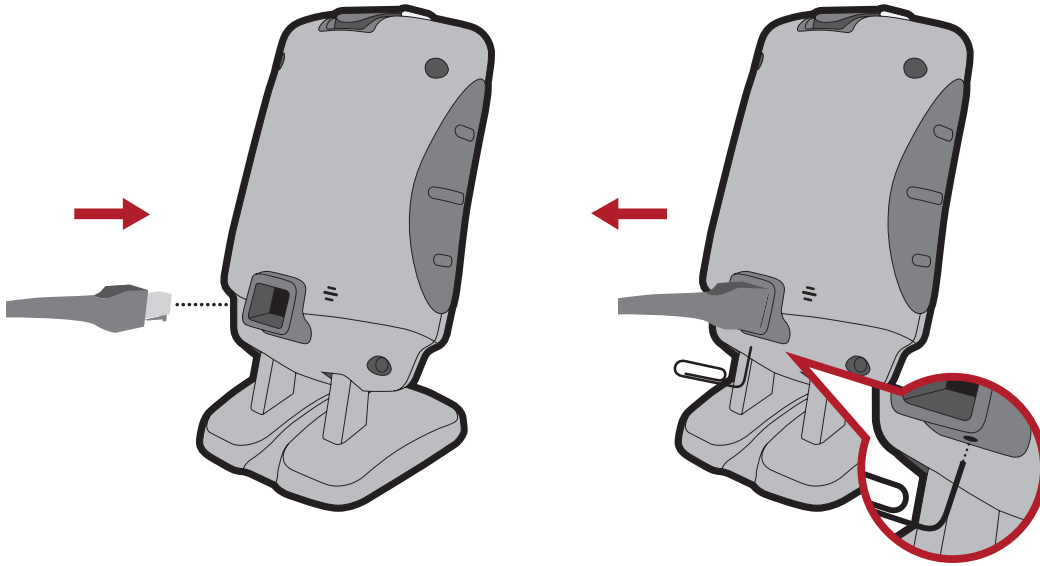

4.0 - RS232 and USB Set Up

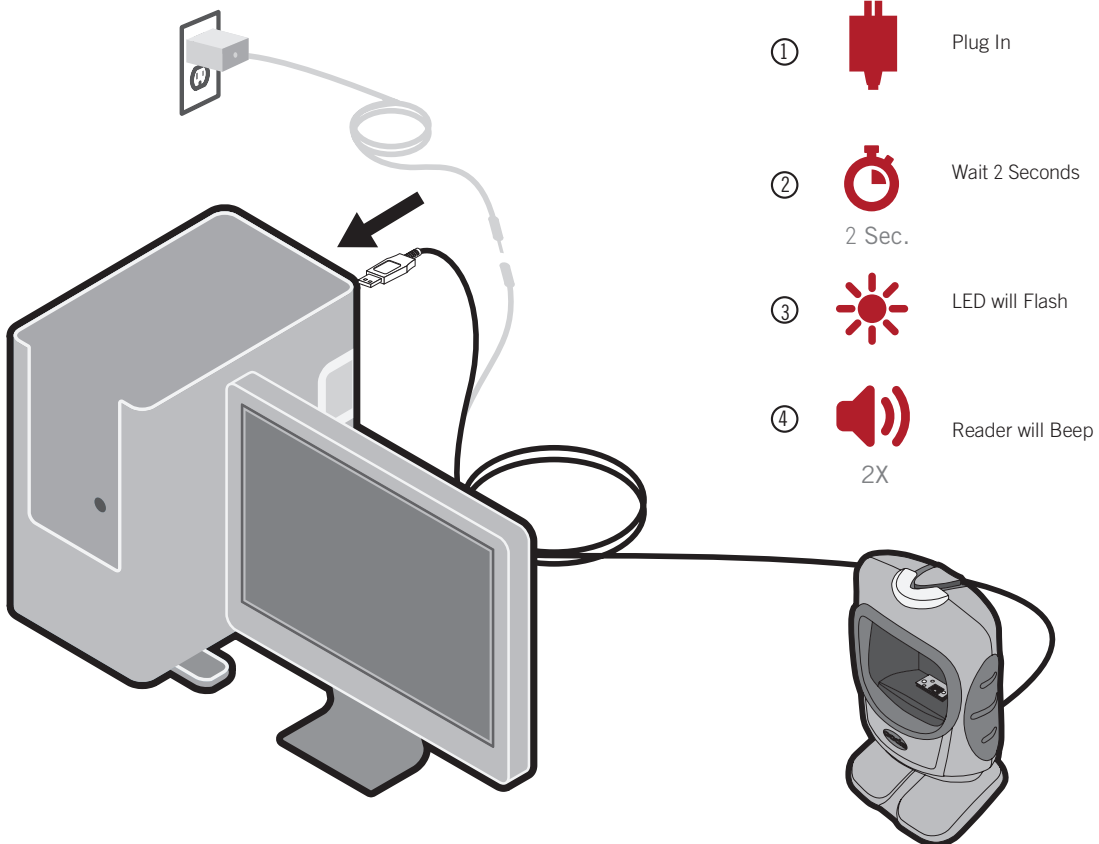

5.0 - Using a CR5200 in Presentation Mode

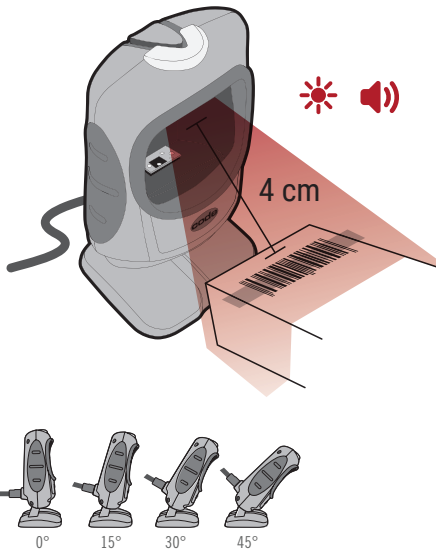

6.0 - Using a CR5200 in Handheld Mode

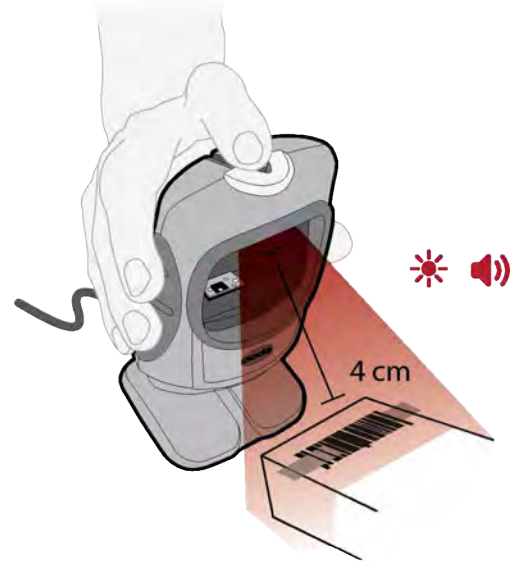











7.0 - Typical Reading Ranges

CR5200 Performance				
Test Barcode	Presentation Mode		Handheld Mode	
	Min Inches (mm)	Max Inches (mm)	Min Inches (mm)	Max Inches (mm)
7.5 mil Code 39	0.4" (10 mm)	5.9" (150 mm)	0.4" (10 mm)	5.1" (131 mm)
10.5 Mil GS1 DataBar	0.4" (10 mm)	6.7" (170 mm)	0.4" (10 mm)	5.4" (138 mm)
13 mil UPC	0.4" (10 mm)	8.0" (203 mm)	0.4" (10 mm)	6.8" (175 mm)
5.8 mil PDF417	0.8" (20 mm)	4.0" (103 mm)	0.6" (16 mm)	3.2" (82 mm)
6.7 mil PDF 417	0.4" (10 mm)	4.8" (122 mm)	0.4" (10 mm)	4.5" (114 mm)
5 mil Data Matrix	1.2" (31 mm)	2.3" (59 mm)	1.0" (25 mm)	2.2" (55 mm)
6.3 mil Data Matrix	0.9" (23 mm)	3.5" (89 mm)	1.1" (27 mm)	3.0" (78 mm)
10 mil Data Matrix	0.4" (10 mm)	5.7" (146 mm)	0.6" (14 mm)	5.0" (126 mm)
20.8 mil Data Matrix	0.4" (10 mm)	8.9" (225 mm)	0.4" (10 mm)	8.4" (213 mm)

Note: All samples were high quality codes and were read along a physical center line at a 10° angle. Default automatic gain control settings were used with regular office lighting. Accuracy= +/- 10%. Testing conditions may affect working ranges. Measured from the front of the device in metric units then converted to Imperial units.

8.0 - Reader Feedback

Scenario	Top LED Light	Sound
CR5200 Successfully Powers Up		 1x
CR5200 Successfully Enumerates with Host (via cable)		 1x
Attempting to Decode		None
Successful Decode and Data Transfer		 1x
Configuration Code Successfully Decoded and Processed		 2x
Configuration Code Successfully Decoded but not Successfully Processed		 4x

9.0 - Symbologies Defaulted On

The following are symbologies that have a default of ON. To turn symbologies on or off, scan the symbology barcodes located in the CR5200 Configuration Guide on the product page at codecorp.com/files.php.

Aztec	All GS1 DataBar
Codabar	Interleaved 2 of 5
Code 39	PDF417
Code 93	QR Code
Code 128	UPC/EAN/JAN
Data Matrix	
Data Matrix Rectangle	

10.0 - Symbologies Defaulted Off

Code barcode readers can read a number of barcode symbologies that are not enabled by default. To turn symbologies on or off, scan the symbology barcodes located in the CR5200 Configuration Guide on the product page at codecorp.com.

Code 11	Micro PDF417
Code 32	MSI Plessey
Code 49 Composite	NEC 2 of 5
Grid Matrix	Pharmacode
Han Xin Code	Plessey
Hong Kong 2 of 5	Postal Codes
IATA 2 of 5	Standard 2 of 5
Matrix 2 of 5	Telepen
Maxicode	Trioptic

13.0 - CR5200 Overall Dimensions

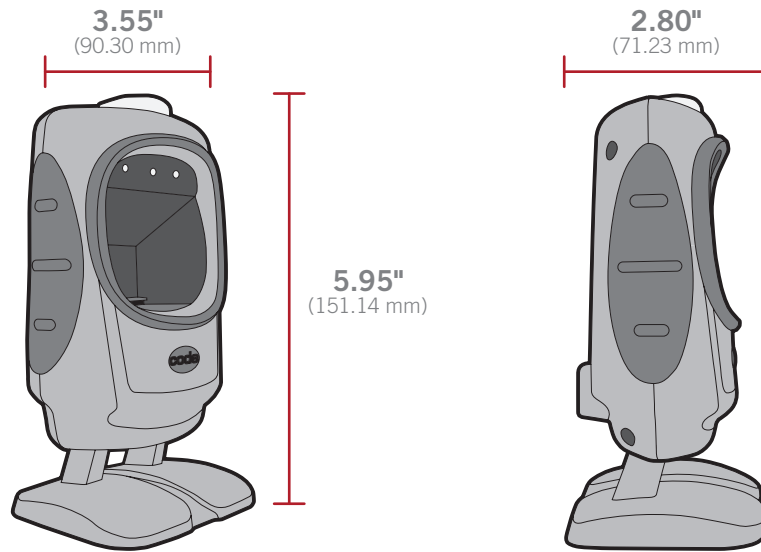

14.0 - USB Cable Example with Pinouts

NOTES:

1. Part to be ROHS and Reach compliant.
2. Maximum Voltage Tolerance = 5V +/- 10%.
3. Caution: Exceeding the maximum voltage will void manufacturer warranty.

CONNECTOR A	NAME	CONNECTOR B
1	VIN	1
2	D-	2
3	D+	3
4	GND	10
SHELL	SHIELD	N/C

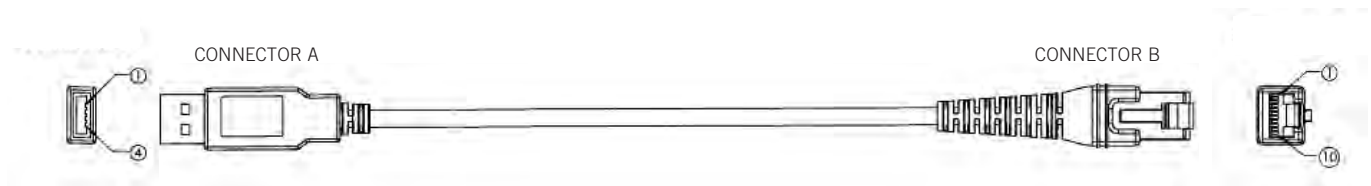

15.0 - RS232 Cable Example with Pinouts

NOTES:

1. Part to be ROHS and Reach compliant.
2. Maximum Voltage Tolerance = 5V +/- 10%.
3. Caution: Exceeding the maximum voltage will void manufacturer warranty.

CONNECTOR A	NAME	CONNECTOR B	CONNECTOR C
1	VIN	9	TIP
4	TX	2	
5	RTS	8	
6	RX	3	
7	CTS	7	
10	GND	5	RING
N/C	SHIELD	SHELL	

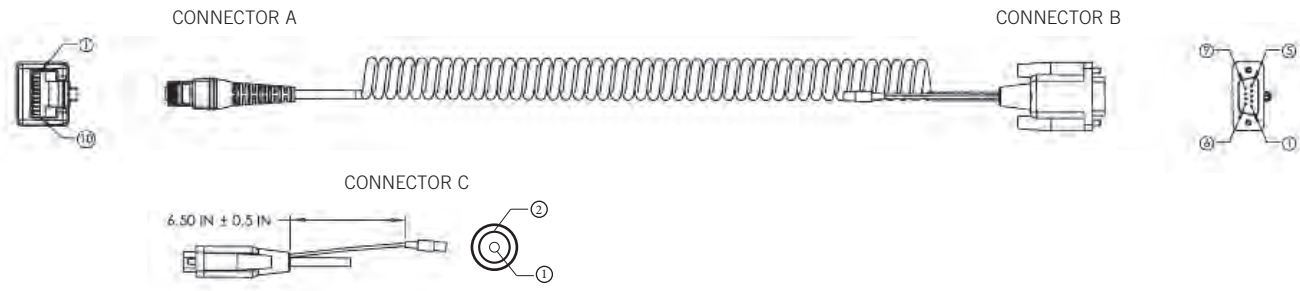

*Diode on Pin 9 of Connector A prevents back-powering of host.

16.0 - Reader Pinouts

The connector on the CR5200 is an RJ-50 (10P-10C). The pinouts are as follows:

Pin 1	+VIN (5v)	Pin 6	RS232 RX (input to reader)
Pin 2	USB_D-	Pin 7	RS232 CTS (input to reader)
Pin 3	USB_D+	Pin 8	N/C
Pin 4	RS232 TX (output from reader)	Pin 9	N/C
Pin 5	RS232 RTS (output from reader)	Pin 10	Ground

17.0 - CR5200 Series Maintenance

The **CR5200** series devices need only a minimum amount of maintenance to operate. A few tips are given below for maintenance suggestions.

Cleaning the CR5200 Series Window

The CR5200 window should be clean to allow the best performance of the device. The window is the clear plastic piece inside the head of the reader. Do not touch the window. Your **CR5200** uses CMOS technology that is much like a digital camera. A dirty window may stop the **CR5200** from reading barcodes. If the window becomes dirty, clean it with a soft, non-abrasive cloth or a facial tissue (no lotions or additives) that has been moistened with water.

Technical Support and Returns

For returns or technical support visit www.codecorp.com/

18.0 - Warranty

Visit www.codecorp.com/ to view warranty periods.

Limited Warranty. Code warrants each Code product against defects in materials and workmanship under normal use for the Warranty Coverage Term applicable to the product as described at www.codecorp.com/legal/warranty/term.php. If a hardware defect arises and a valid warranty claim is received by Code during the Warranty Coverage Term, Code will either: i) repair a hardware defect at no charge, using new parts or parts equivalent to new in performance and reliability; ii) replace the Code product with a product that is new or refurbished product with equivalent functionality and performance, which may include replacing a product that is no longer available with a newer model product; or ii) in the case of failure with any software, including embedded software included in any Code product, provide a patch, update, or other work around. All replaced products become the property of Code. All warranty claims must be made using Code's RMA process.

Exclusions. This warranty does not apply to: i) cosmetic damage, including but not limited to scratches, dents, and broken plastic; ii) damage resulting from use with non-Code products or peripherals, including batteries, power supplies, cables, and docking station/cradles; iii) damage resulting from accident, abuse, misuse, flood, fire or other external causes, including damage caused by unusual physical or electrical stress, immersion in fluids or exposure to cleaning products not approved by Code, puncture, crushing, and incorrect voltage or polarity; iv) damage resulting from services performed by anyone other than a Code authorized repair facility; v) any product that has been modified or altered; vi) any product on which the Code serial number has been removed or defaced. If a Code Product is returned under a warranty claim and Code determines, in Code's sole discretion, that the warranty remedies do not apply, Code will contact Customer to arrange either: i) repair or replace the Product; or ii) return the Product to Customer, in each case at Customer's expense.

Non Warranty Repairs. Code warrants its repair/replacement services for ninety (90) days from the date of shipment of the repaired/replacement product to the Customer. This warranty applies to repairs and replacements for: i) damage excluded from the limited warranty described above; and ii) Code Products on which the limited warranty described above has expired (or will expire within such ninety (90) day warranty period). For repaired product this warranty covers only the parts that were replaced during the repair and the labor associated with such parts.

No Extension of Term of Coverage. Product that is repaired or replaced, or for which a software patch, update, or other work around is provided, assumes the remaining warranty of the original Code Product and does not extend the duration of the original warranty period.

Software and Data. Code is not responsible for backing up or restoring any of software, data, or configuration settings, or reinstalling any of the foregoing on products repaired or replaced under this limited warranty.

Shipping and Turn Around Time. The estimated RMA turn-around time from receipt at Code's facility to shipment of the repaired or replaced product to Customer is ten (10) business days. An expedited turn-around time may apply to products covered under certain CodeOne Service Plans. Customer is responsible for shipping and insurance charges for shipping Code Product to Code's designated RMA facility and repaired or replaced product is returned with shipping and insurance paid by Code. Customer is responsible for all applicable taxes, duties, and similar charges.

Transfer. If a customer sells a covered Code Product during the Warranty Coverage Term, then that coverage may be transferred to the new owner by written notification from the original owner to Code Corporation at:

CodeOne Service Center
434 West Ascension Way, Suite 300
Murray, UT 84123

Limitation on Liability. Code's performance as described herein shall be Code's entire liability, and the Customer's sole remedy, resulting from any defective Code product. Any claim that Code has failed to perform its warranty obligations as described herein must be made within six (6) months of the alleged failure. Code's maximum liability related to its performance, or failure to perform, as described herein shall be limited to the amount paid by Customer for the Code product that is subject to the claim. In no event will either party be liable for any lost profits, lost savings, incidental damage, or other economic consequential damages. This is true even if the other party is advised of the possibility of such damages.

EXCEPT AS MAY BE OTHERWISE PROVIDED BY APPLICABLE LAW, THE LIMITED WARRANTIES DESCRIBE HEREIN REPRESENT THE ONLY WARRANTIES CODE MAKES WITH RESPECT TO ANY PRODUCT. CODE DISCLAIMS ALL OTHER WARRANTIES, WHETHER EXPRESSED OR IMPLIED, ORAL OR WRITTEN, INCLUDING WITHOUT LIMITATION IMPLIED WARRANTIES OF MERCHANTABILITY, FITNESS FOR A PARTICULAR PURPOSE AND NON-INFRINGEMENT.

THE REMEDIES DESCRIBED HEREIN REPRESENT CUSTOMER'S EXCLUSIVE REMEDY, AND CODE'S ENTIRE RESPONSIBILITY, RESULTING FROM ANY DEFECTIVE CODE PRODUCT. CODE SHALL NOT BE LIABLE TO CUSTOMER (OR TO ANY PERSON OR ENTITY CLAIMING THROUGH CUSTOMER) FOR LOST PROFITS, LOSS OF DATA, DAMAGE TO ANY EQUIPMENT WITH WHICH THE CODE PRODUCT INTERFACES (INCLUDING ANY MOBILE TELEPHONE, PDA, OR OTHER COMPUTING DEVICES), OR FOR ANY SPECIAL, INCIDENTAL, INDIRECT, CONSEQUENTIAL OR EXEMPLARY DAMAGES ARISING OUT OF OR IN ANY MANNER CONNECTED WITH THE PRODUCT, REGARDLESS OF THE FORM OF ACTION AND WHETHER OR NOT CODE HAS BEEN INFORMED OF, OR OTHERWISE MIGHT HAVE ANTICIPATED, THE POSSIBILITY OF SUCH DAMAGES.

*North America Warranty Period.